

PIC16C774 Rev. B Silicon Errata Sheet

The PIC16C774 (Rev. B) parts you have received conform functionally to the Device Data Sheet (DS30275A), except for the anomalies described below.

All of the problems listed here will be addressed in future revisions of the PIC16C774 silicon.

1. Module: VREF

If the VRH high voltage reference is enabled and also used as a reference source for the A/D converter, the VRHOEN bit (REFCON<5>) must be set. Since setting the VRHOEN bit connects the VRH reference to the RA3 pin, the TRISA<3> bit must be maintained set and the pin cannot be used for general purpose I/O.

The VRL low voltage reference does not function properly on parts with date codes earlier than 0012NNN, where the first two digits are the year and the second two are the work week. Laser marked parts are made after this date and have a functional VRL. In parts without functional VRL, the VRLEN (REFCON<6>) and VRLOEN (REFCON<4>) bits should be maintained cleared.

Work around

None.

2. Module: PORTE

The minimum V_{IH} specification for PORTE (parameter D040) is 2.2 volts. The maximum V_{IL} specification for PORTE (parameter D030A) is 0.6 volts.

Work around

None.

3. Module: BOR

The Brown-out Reset module's selection ranges have changed. Table 1 shows the new specifications.

Work around

None.

Date Codes Pertaining To This Issue:

All.

Note: When the manufacture date of a newer version of silicon is in production, the last date where this issue may occur will be specified.

TABLE 1: DC SPECIFICATION CHANGES FROM DATA SHEET

Param No.	Sym.	Characteristic		Tested Specification			Data Sheet Specification			Units
				Min	Typ	Max	Min	Typ	Max	
D005	VBOR	BOR Voltage	BORV<1:0> = 0100	2.35	—	2.80	2.5	—	2.66	V
			BORV<1:0> = 0101	2.55	—	3.02	2.7	—	2.86	V
			BORV<1:0> = 0110	3.95	—	4.71	4.2	—	4.46	V
			BORV<1:0> = 0111	4.23	—	5.05	4.5	—	4.78	V

PIC16C774

4. Module: LVD

The Low Voltage Detect module's selection ranges have changed. Table 2 shows the new specifications.

Work around

None.

Date Codes Pertaining To This Issue:

All.

Note: When the manufacture date of a newer version of silicon is in production, the last date where this issue may occur will be specified.

TABLE 2: DC SPECIFICATION CHANGES FROM DATA SHEET

Param No.	Sym.	Characteristic		Tested Specification			Data Sheet Specification			Units
				Min	Typ	Max	Min	Typ	Max	
D420	VLVD	LVD Voltage	LVV<3:0> = 0100	2.35	—	2.80	2.5	—	2.66	V
			LVV<3:0> = 0101	2.55	—	3.02	2.7	—	2.86	V
			LVV<3:0> = 0110	2.64	—	3.14	2.8	—	2.98	V
			LVV<3:0> = 0111	2.83	—	3.37	3.0	—	3.2	V
			LVV<3:0> = 1000	3.11	—	3.71	3.3	—	3.52	V
			LVV<3:0> = 1001	3.29	—	3.93	3.5	—	3.72	V
			LVV<3:0> = 1010	3.39	—	4.04	3.6	—	3.84	V
			LVV<3:0> = 1011	3.58	—	4.26	3.8	—	4.04	V
			LVV<3:0> = 1100	3.77	—	4.49	4.0	—	4.26	V
			LVV<3:0> = 1101	3.95	—	4.71	4.2	—	4.46	V
			LVV<3:0> = 1110	4.23	—	5.05	4.5	—	4.78	V

5. Module: Timer1

When Timer1 is running in Asynchronous mode and then disabled, data in the Timer1 register (TMR1) may become corrupted. Corruption occurs when the timer enable is turned off at the same instant that a ripple carry occurs in the timer module.

This issue only occurs in asynchronous operation. In synchronous operation, the relevant signals are latched with the CPU clock and the problem condition does not arise.

Work around

When Timer1 is configured to operate as an asynchronous counter, care must be taken that there is no incoming pulse while the module is being turned off. If an incoming pulse arrives while Timer1 is being turned off, the value of register TMR1 may become corrupted.

If an application requires that Timer1 be turned off, and if it is possible that Timer1 may receive an incoming pulse while being turned off, synchronize the external clock first by clearing the T1SYNC bit of register T1CON (T1CON<2>). Please note, however, that this may cause Timer1 to miss up to one count.

6. Module: A/D Converter

Exceptions have been observed in the differential linearity error specification (parameter A04), as listed in Table 15-9 of the Data Sheet.

No missing codes have been observed when using up to, and including, 11-bits of resolution. At 12-bits of resolution, up to four missing codes may occur. The missing codes will never be adjacent.

Work around

None.

PIC16C774

Clarifications/Corrections to the Data Sheet:

In the Device Data Sheet (DS30275A), the following clarifications and corrections should be noted.

1. Table 15-1 in the Device Data Sheet (DS30275A) should be omitted. Figure 15-1 and Figure 15-2 below should be used to determine the operating voltages and frequencies for the devices.

FIGURE 15-1: PIC16C773/774 VOLTAGE-FREQUENCY GRAPH, $-40^{\circ}\text{C} \leq T_A \leq +85^{\circ}\text{C}$

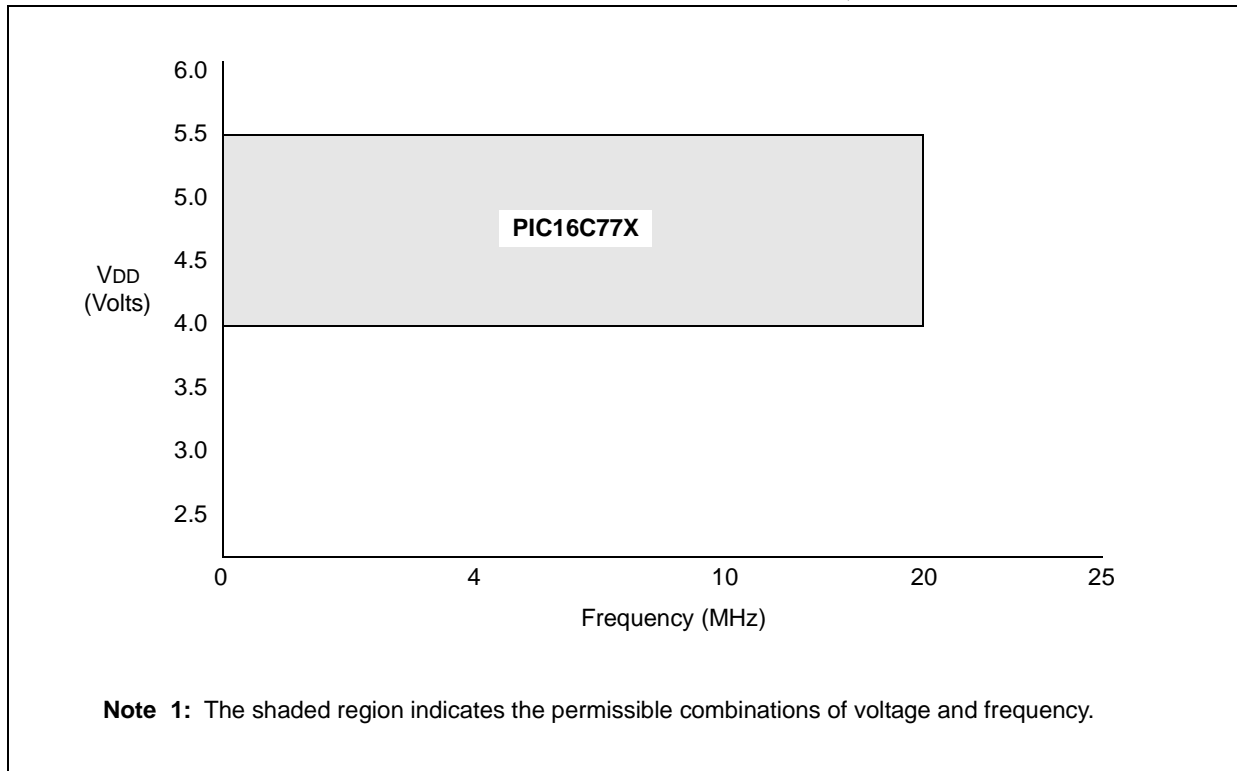
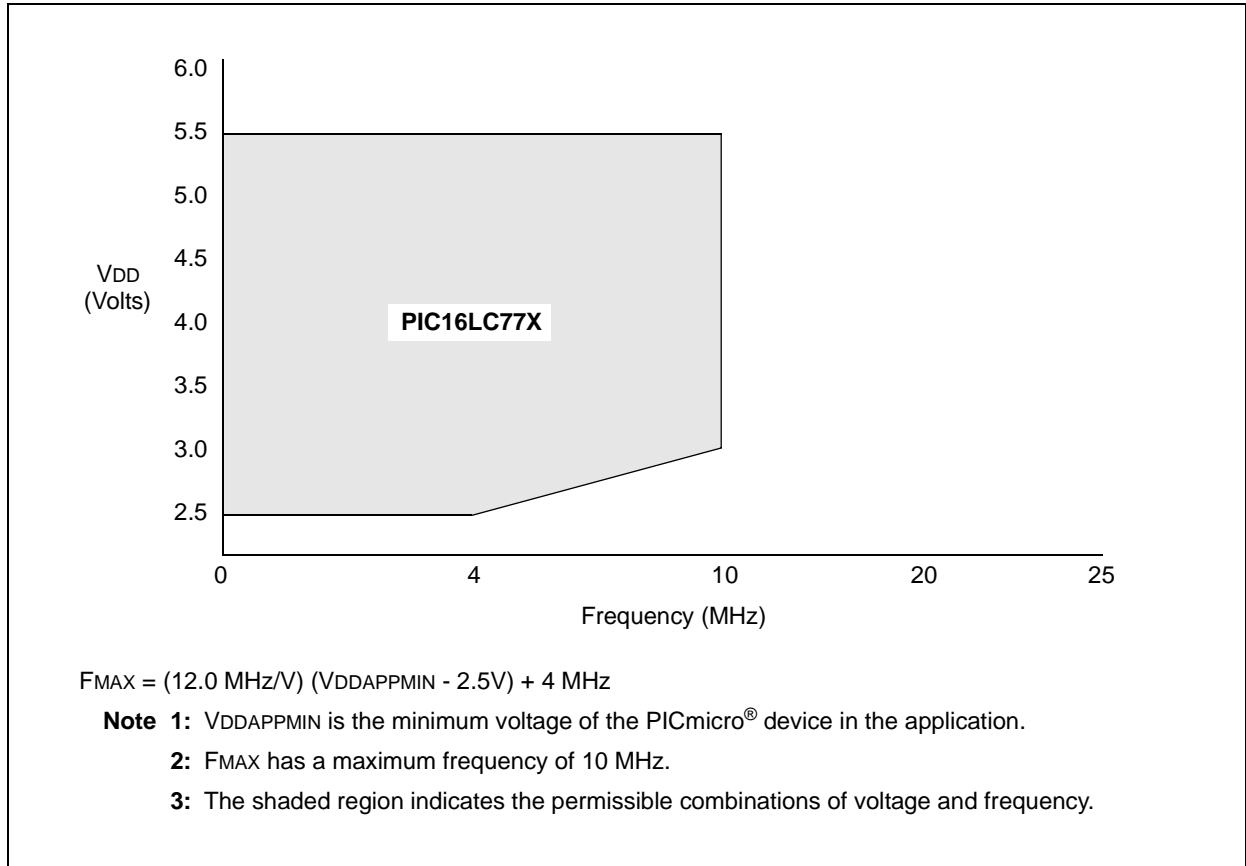

FIGURE 15-2: PIC16LC773/774 VOLTAGE-FREQUENCY GRAPH, $-40^{\circ}\text{C} \leq T_A \leq +85^{\circ}\text{C}$



PIC16C774

2. The details of the new Product Identification System are given below. This information replaces the Product Identification System details given in the Device Data Sheet (DS30275A).

PIC16C774 PRODUCT IDENTIFICATION SYSTEM

To order or obtain information, e.g., on pricing or delivery, refer to the factory or the listed sales office.

PART NO. -	X /XX XXX		Examples
		Pattern:	QTP, SQTP, Code or Special Requirements
		Package:	JW = Windowed CERDIP SO = SOIC P = PDIP SS = SSOP L = PLCC SP = Skinny Plastic Dip PQ = MQFP (Metric PQFP) PT = TQFP (Thin Quad Flatpack)
		Temperature Range:	- = 0°C to +70°C I = -40°C to +85°C
		Device	PIC16C773 : V _{DD} range 4.0V to 5.5V PIC16C773T : V _{DD} range 4.0V to 5.5V (Tape/Reel) PIC16LC773 : V _{DD} range 2.5V to 5.5V PIC16LC773T: V _{DD} range 2.5V to 5.5V (Tape/Reel) PIC16C774 : V _{DD} range 4.0V to 5.5V PIC16C774T : V _{DD} range 4.0V to 5.5V (Tape/Reel) PIC16LC774 : V _{DD} range 2.5V to 5.5V PIC16LC774T: V _{DD} range 2.5V to 5.5V (Tape/Reel)
			a) PIC16C774/P = Commercial Temp., PDIP Package, normal V _{DD} limits.

*JW devices are UV erasable and can be programmed to any device configuration. JW devices meet the electrical requirement of each oscillator type (including LC devices).

3. The PIC16C77X devices contain new package marking information. The package marking details provided below replace those given in Section 17 of the Device Data Sheet (DS30275A).

17.1 Package Marking Information

28-Lead PDIP (Skinny DIP)

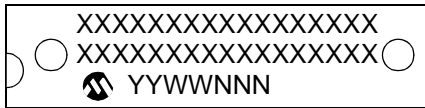

Example

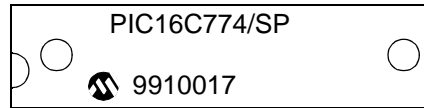

28-Lead CERDIP Windowed

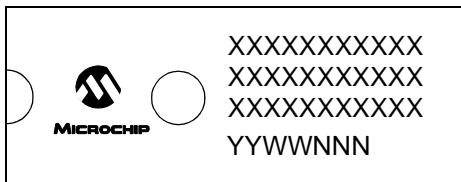

Example

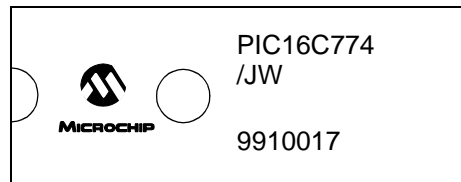

28-Lead SOIC



Example

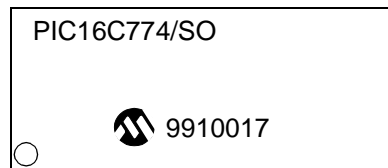

28-Lead SSOP

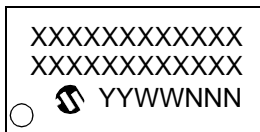

Example



Legend: XX...X Customer specific information*
 YY Year code (last 2 digits of calendar year)
 WW Week code (week of January 1 is week '01')
 NNN Alphanumeric traceability code

Note: In the event the full Microchip part number cannot be marked on one line, it will be carried over to the next line thus limiting the number of available characters for customer specific information.

* Standard OTP marking consists of Microchip part number, year code, week code and traceability code. For OTP marking beyond this, certain price adders apply. Please check with your Microchip Sales Office. For QTP devices, any special marking adders are included in QTP price.

PIC16C774

Package Marking Information (Cont'd)

40-Lead PDIP

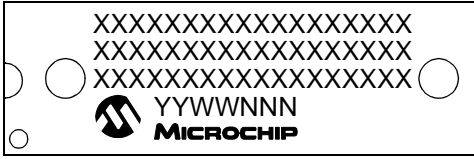

Example

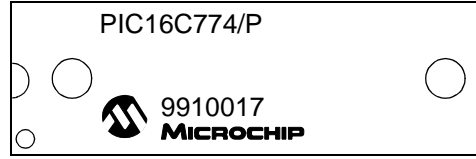

40-Lead CERDIP Windowed

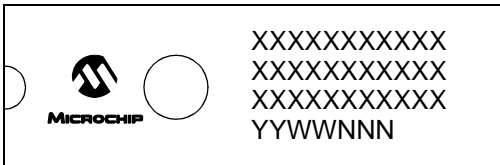

Example

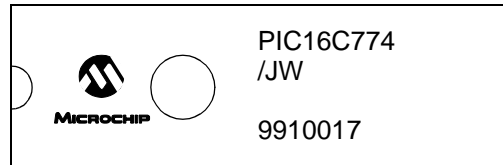

44-Lead TQFP

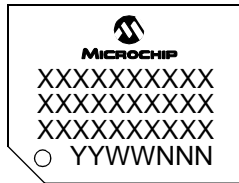

Example

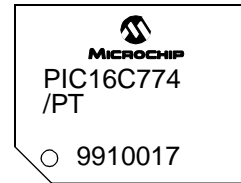

44-Lead MQFP

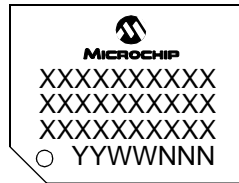

Example

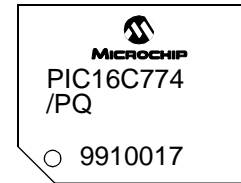

44-Lead PLCC

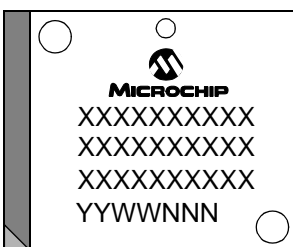

Example

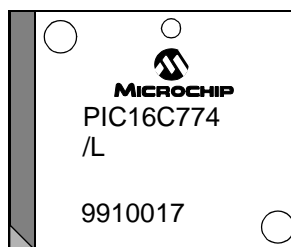

4. The A/D module differential current has been improved to the values shown in Table 3.

TABLE 3: DC SPECIFICATION CHANGES FROM DATA SHEET

Param No.	Sym.	Characteristic	New Specification			Data Sheet Specification			Units	Conditions
			Min	Typ	Max	Min	Typ	Max		
D026	ΔI_{AD}	Module Differential Current (Note 5)								
		A/D Converter								
		PIC16 C XXX	—	10	—	—	300	—	μA	$V_{DD} = 4.0V$; A/D on, not converting
		PIC16 L CXXX	—	10	—	—	300	—	μA	$V_{DD} = 3.0V$; A/D on, not converting

Note 5: The Δ current is the additional current consumed when the peripheral is enabled. This current should be added to the base (I_{PD} or I_{DD}) current.

5. The Voltage Reference module line regulation specification has been changed to the values shown in Table 4. The new specification is shown in **bold**.

TABLE 4: DC SPECIFICATION CHANGES FROM DATA SHEET

Param No.	Sym.	Characteristic	New Specification			Data Sheet Specification			Units
			Min	Typ	Max	Min	Typ	Max	
D407	$\Delta V_{OUT}/\Delta V_{DD}$	Line Regulation	—	1000	—	—	—	50	$\mu V/V$

PIC16C774

6. The Low Voltage Detect module supply current specification has been changed to the values shown in Table 5.

TABLE 5: DC SPECIFICATION CHANGES FROM DATA SHEET

Param No.	Sym.	Characteristic	New Specification			Data Sheet Specification			Units
			Min	Typ	Max	Min	Typ	Max	
D421	Δ LVD	LVD Supply Current	—	10	TBD	—	10	20	μ A

7. The Brown-out Reset module supply current specification has been modified to the values shown in Table 6.

TABLE 6: DC SPECIFICATION CHANGES FROM DATA SHEET

Param No.	Sym.	Characteristic	New Specification			Data Sheet Specification			Units
			Min	Typ	Max	Min	Typ	Max	
D022A	Δ BOR	Supply Current	—	10	TBD	—	10	20	μ A

8. The A/D clock source bits (ADCS1:ADCS0) have had their operation modified. See Register 1 for a new definition of the ADCS1 and ADCS0 bits.

Figure 1 shows how the TAD time is determined based upon the selection of the ADCS<1:0> bits and the source of VREF+ and VREF-. When VREF+ or VREF- comes from the internal voltage reference (VRH or VRL), then the required TAD time is increased by a factor of eight (see electrical specification parameter #130A).

The clock source selected by the ADCS<1:0> bits is divided by eight when an internally generated reference voltage is used as reference to the A/D module. This automatically addresses the requirement for the TAD time, when the internal voltage reference is used as the A/D voltage reference.

FIGURE 1: A/D CLOCK SOURCE BLOCK DIAGRAM

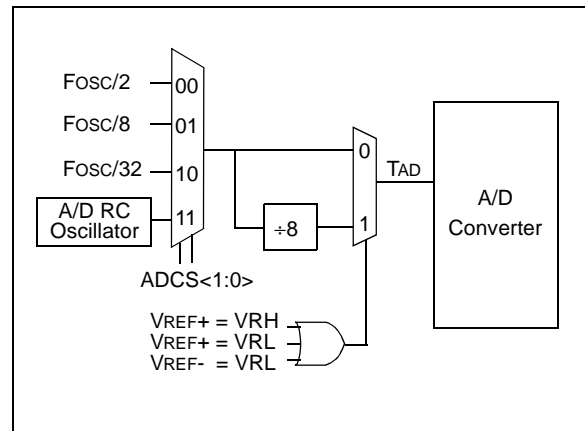

Note: Electrical specification parameter #130A is currently specified in the clarifications and corrections section of the Device Errata Sheet.

Table 7 shows the maximum device frequency depending on the A/D clock source selected.

REGISTER 1: A/D CONTROL REGISTER 0 (ADCON0)

R/W-0	R/W-0	R/W-0	R/W-0	R/W-0	R/W-0	R/W-0	R/W-0
ADCS1	ADCS0	CHS2	CHS1	CHS0	GO/DONE	CHS3	ADON
bit 7						bit 0	

bit 7-6 **ADCS<1:0>**: A/D Conversion Clock Select bits

ADCS<1:0>	A/D Clock Source (TAD) =	
	When VCFG<2:0> = 000, 001, 011 or 101	When VCFG<2:0> = 010, 100, 110 or 111
00	2 TOSC	16 TOSC
01	8 TOSC	64 TOSC
10	32 TOSC	256 TOSC
11	A/D RC (1 MHz max)	A/D RC (125 kHz max)

bit 5-0 No change to the operation of these bits

Legend:

R = Readable bit	W = Writable bit	U = Unimplemented bit, read as '0'
- n = Value at POR	'1' = Bit is set	'0' = Bit is cleared x = Bit is unknown

PIC16C774

TABLE 7: MAXIMUM DEVICE FREQUENCY vs. A/D CLOCK SOURCE

ADCS<1:0>	A/D Clock Source (TAD)		Maximum Device Frequency
	When A/D Reference is selected as External Reference or Analog Supply TAD $\geq 1.6 \mu\text{s}$	When A/D Reference is selected as Internal VRH or VRL TAD $\geq 12.8 \mu\text{s}$	
00	2 TOSC	16 TOSC	1.25 MHz
01	8 TOSC	64 TOSC	5 MHz
10	32 TOSC	256 TOSC	20 MHz
11	A/D RC	A/D RC	— (1,3)

Note 1: The A/D RC source has a typical TAD time of 4 μs for VDD > 3.0V, but can vary between 2 μs and 6 μs .
Note 2: The A/D RC source has a typical TAD time of 32 μs for VDD > 3.0V, but can vary between 16 μs and 48 μs .
Note 3: When the device frequency is greater than 1 MHz, the A/D RC clock source is only recommended if the conversion will be performed during SLEEP.

9. The 12-bit A/D module requires some new timing specifications for the A/D clock period (minimum TAD time). These new specifications are for when the reference voltage for the A/D is selected as either the VRH or VRL reference voltage. The new specifications are shown in **bold** in Table 8.

TABLE 8: DC SPECIFICATION CHANGES FROM DATA SHEET

Parm No.	Sym	Characteristic		New Specification			Data Sheet Specification			Units	Condition
				Min	Typ	Max	Min	Typ	Max		
130	TAD	A/D Clock Period	Clock from FOSC	1.6	—	—	1.6	—	—	μs	VREF ≥ 2.5V
				TBD	—	—	TBD	—	—	μs	VREF full range
				12.8	—	—	N.A.	N.A.	N.A.	μs	VRH or VRL used as A/D reference voltage, VDD = 5.0V
		Clock from internal A/D RC oscillator ADCS<1:0> = 11	3.0	6.0	9.0	3.0	6.0	9.0	μs	VDD = 2.5V	
			2.0	4.0	6.0	2.0	4.0	6.0	μs	VDD = 5.0V	
			16	32	48	N.A.	N.A.	N.A.	μs	VRH or VRL used as A/D reference voltage, VDD = 5.0V	

10. The output voltage specification in the DC Characteristics section has been modified to the values shown in Table 9. The new values are shown in **bold**.

TABLE 9: DC SPECIFICATION CHANGES FROM DATA SHEET

Param No.	Characteristic	Symbol	New Specification			Data Sheet Specification			Units
			Min	Typ	Max	Min	Typ	Max	
D400	Output Voltage	VRL	1.9	2.048	2.2	2.0	2.048	2.1	V
		VRH	4.0	4.096	4.3	—	4.096	4.2	V

PIC16C774

REVISION HISTORY

Rev C Document (1/01)

Item 10 and Table 9, concerning output voltage specifications, were added.

Rev D Document (2/01)

Issues 5 (Timer1) and 6 (A/D Converter) were added (page 3).

“All rights reserved. Copyright © 2001, Microchip Technology Incorporated, USA. Information contained in this publication regarding device applications and the like is intended through suggestion only and may be superseded by updates. No representation or warranty is given and no liability is assumed by Microchip Technology Incorporated with respect to the accuracy or use of such information, or infringement of patents or other intellectual property rights arising from such use or otherwise. Use of Microchip’s products as critical components in life support systems is not authorized except with express written approval by Microchip. No licenses are conveyed, implicitly or otherwise, under any intellectual property rights. The Microchip logo and name are registered trademarks of Microchip Technology Inc. in the U.S.A. and other countries. All rights reserved. All other trademarks mentioned herein are the property of their respective companies. No licenses are conveyed, implicitly or otherwise, under any intellectual property rights.”

Trademarks

The Microchip name, logo, PIC, PICmicro, PICMASTER, PICSTART, PRO MATE, KEELOQ, SEEVAL, MPLAB and The Embedded Control Solutions Company are registered trademarks of Microchip Technology Incorporated in the U.S.A. and other countries.

Total Endurance, ICSP, In-Circuit Serial Programming, Filter-Lab, MXDEV, microID, FlexROM, fuzzyLAB, MPASM, MPLINK, MPLIB, PICDEM, ICEPIC, Migratable Memory, FanSense, ECONOMONITOR, SelectMode and microPort are trademarks of Microchip Technology Incorporated in the U.S.A.

Serialized Quick Term Programming (SQTP) is a service mark of Microchip Technology Incorporated in the U.S.A.

All other trademarks mentioned herein are property of their respective companies.

© 2001, Microchip Technology Incorporated, Printed in the U.S.A., All Rights Reserved.

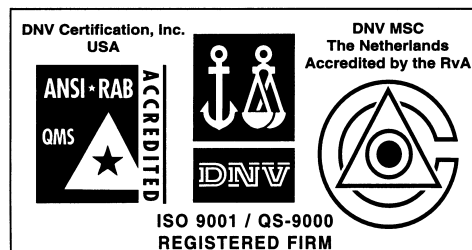

Microchip received QS-9000 quality system certification for its worldwide headquarters, design and wafer fabrication facilities in Chandler and Tempe, Arizona in July 1999. The Company's quality system processes and procedures are QS-9000 compliant for its PICmicro® 8-bit MCUs, KEELoC® code hopping devices, Serial EEPROMs and microperipheral products. In addition, Microchip's quality system for the design and manufacture of development systems is ISO 9001 certified.



WORLDWIDE SALES AND SERVICE

AMERICAS

Corporate Office

2355 West Chandler Blvd.
Chandler, AZ 85224-6199
Tel: 480-792-7200 Fax: 480-792-7277
Technical Support: 480-792-7627
Web Address: <http://www.microchip.com>

Rocky Mountain

2355 West Chandler Blvd.
Chandler, AZ 85224-6199
Tel: 480-792-7966 Fax: 480-792-7456

Atlanta

500 Sugar Mill Road, Suite 200B
Atlanta, GA 30350
Tel: 770-640-0034 Fax: 770-640-0307

Austin

Analog Product Sales
8303 MoPac Expressway North
Suite A-201
Austin, TX 78759
Tel: 512-345-2030 Fax: 512-345-6085

Boston

2 Lan Drive, Suite 120
Westford, MA 01886
Tel: 978-692-3848 Fax: 978-692-3821

Boston

Analog Product Sales
Unit A-8-1 Millbrook Tarry Condominium
97 Lowell Road
Concord, MA 01742
Tel: 978-371-6400 Fax: 978-371-0050

Chicago

333 Pierce Road, Suite 180
Itasca, IL 60143
Tel: 630-285-0071 Fax: 630-285-0075

Dallas

4570 Westgrove Drive, Suite 160
Addison, TX 75001
Tel: 972-818-7423 Fax: 972-818-2924

Dayton

Two Prestige Place, Suite 130
Miamisburg, OH 45342
Tel: 937-291-1654 Fax: 937-291-9175

Detroit

Tri-Atria Office Building
32255 Northwestern Highway, Suite 190
Farmington Hills, MI 48334
Tel: 248-538-2250 Fax: 248-538-2260

Los Angeles

18201 Von Karman, Suite 1090
Irvine, CA 92612
Tel: 949-263-1888 Fax: 949-263-1338

Mountain View

Analog Product Sales
1300 Terra Bella Avenue
Mountain View, CA 94043-1836
Tel: 650-968-9241 Fax: 650-967-1590

New York

150 Motor Parkway, Suite 202
Hauppauge, NY 11788
Tel: 631-273-5305 Fax: 631-273-5335

San Jose

Microchip Technology Inc.
2107 North First Street, Suite 590
San Jose, CA 95131
Tel: 408-436-7950 Fax: 408-436-7955

Toronto

6285 Northam Drive, Suite 108
Mississauga, Ontario L4V 1X5, Canada
Tel: 905-673-0699 Fax: 905-673-6509

ASIA/PACIFIC

Australia

Microchip Technology Australia Pty Ltd
Suite 22, 41 Rawson Street
Epping 2121, NSW
Australia
Tel: 61-2-9868-6733 Fax: 61-2-9868-6755

China - Beijing

Microchip Technology Beijing Office
Unit 915
New China Hong Kong Manhattan Bldg.
No. 6 Chaoyangmen Beidajie
Beijing, 100027, No. China
Tel: 86-10-85282100 Fax: 86-10-85282104

China - Shanghai

Microchip Technology Shanghai Office
Room 701, Bldg. B
Far East International Plaza
No. 317 Xian Xia Road
Shanghai, 200051
Tel: 86-21-6275-5700 Fax: 86-21-6275-5060

Hong Kong

Microchip Asia Pacific
RM 2101, Tower 2, Metroplaza
223 Hing Fong Road
Kwai Fong, N.T., Hong Kong
Tel: 852-2401-1200 Fax: 852-2401-3431

India

Microchip Technology Inc.
India Liaison Office
Divyasree Chambers
1 Floor, Wing A (A3/A4)
No. 11, O'Shaughnessey Road
Bangalore, 560 025, India
Tel: 91-80-2290061 Fax: 91-80-2290062

Japan

Microchip Technology Intl. Inc.
Benex S-1 6F
3-18-20, Shinyokohama
Kohoku-Ku, Yokohama-shi
Kanagawa, 222-0033, Japan
Tel: 81-45-471-6166 Fax: 81-45-471-6122

ASIA/PACIFIC (continued)

Korea

Microchip Technology Korea
168-1, Youngbo Bldg. 3 Floor
Samsung-Dong, Kangnam-Ku
Seoul, Korea
Tel: 82-2-554-7200 Fax: 82-2-558-5934

Singapore

Microchip Technology Singapore Pte Ltd.
200 Middle Road
#07-02 Prime Centre
Singapore, 188980
Tel: 65-334-8870 Fax: 65-334-8850

Taiwan

Microchip Technology Taiwan
11F-3, No. 207
Tung Hua North Road
Taipei, 105, Taiwan
Tel: 886-2-2717-7175 Fax: 886-2-2545-0139

EUROPE

Denmark

Microchip Technology Denmark ApS
Regus Business Centre
Lautrup høj 1-3
Ballerup DK-2750 Denmark
Tel: 45 4420 9895 Fax: 45 4420 9910

France

Arizona Microchip Technology SARL
Parc d'Activite du Moulin de Massy
43 Rue du Saule Trapu
Batiment A - 1er Etage
91300 Massy, France
Tel: 33-1-69-53-63-20 Fax: 33-1-69-30-90-79

Germany

Arizona Microchip Technology GmbH
Gustav-Heinemann Ring 125
D-81739 Munich, Germany
Tel: 49-89-627-144 0 Fax: 49-89-627-144-44

Germany

Analog Product Sales
Lochhamer Strasse 13
D-82152 Martinsried, Germany
Tel: 49-89-895650-0 Fax: 49-89-895650-22

Italy

Arizona Microchip Technology SRL
Centro Direzionale Colleoni
Palazzo Taurus 1 V. Le Colleoni 1
20041 Agrate Brianza
Milan, Italy
Tel: 39-039-65791-1 Fax: 39-039-6899883

United Kingdom

Arizona Microchip Technology Ltd.
505 Eskdale Road
Winnersh Triangle
Wokingham
Berkshire, England RG41 5TU
Tel: 44 118 921 5869 Fax: 44-118 921-5820

01/30/01

All rights reserved. © 2001 Microchip Technology Incorporated. Printed in the USA. 2/01  Printed on recycled paper.

Information contained in this publication regarding device applications and the like is intended through suggestion only and may be superseded by updates. It is your responsibility to ensure that your application meets with your specifications. No representation or warranty is given and no liability is assumed by Microchip Technology Incorporated with respect to the accuracy or use of such information, or infringement of patents or other intellectual property rights arising from such use or otherwise. Use of Microchip's products as critical components in life support systems is not authorized except with express written approval by Microchip. No licenses are conveyed, implicitly or otherwise, except as maybe explicitly expressed herein, under any intellectual property rights. The Microchip logo and name are registered trademarks of Microchip Technology Inc. in the U.S.A. and other countries. All rights reserved. All other trademarks mentioned herein are the property of their respective companies.