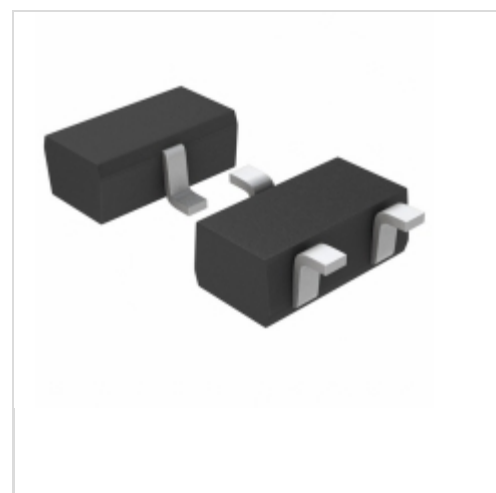

UNR921BJ0L

Panasonic

TRANS PREBIAS NPN 125MW SSMINI3

Contains lead / RoHS non-compliant

Discrete Semiconductor Products

[UNR921BJ0L.pdf](#)
Buy Now

We can supply Panasonic UNR921BJ0L, use the request quote form to request UNR921BJ0L price, Panasonic Datasheet PDF and lead time. Zeanoit.com is a professional electronic components distributor. With 3+ Million line items of available electronic components can ship in short lead-time, over 250 thousand part numbers of electronic components in stock for immediately delivery, which may include part number UNR921BJ0L. The price and lead time for UNR921BJ0L depending on the quantity required, availability and warehouse location.

Shopping Process

1
Confirm the product
2
submit the order
3
payment
4
wait for delivery
5
receive the goods

Specifications

Voltage - Collector Emitter Breakdown (Max):	50V
Vce Saturation (Max) @ Ib, Ic:	250mV @ 300µA, 10mA
Transistor Type:	NPN - Pre-Biased
Supplier Device Package:	SSMini3-F1
Series:	-
Resistor - Emitter Base (R2) (Ohms):	-
Resistor - Base (R1) (Ohms):	100k
Power - Max:	125mW
Packaging:	Tape & Reel (TR)
Package / Case:	SC-89, SOT-490
Mounting Type:	Surface Mount
Frequency - Transition:	150MHz
DC Current Gain (hFE) (Min) @ Ic, Vce:	160 @ 5mA, 10V
Current - Collector Cutoff (Max):	500nA
Current - Collector (Ic) (Max):	100mA

Related products

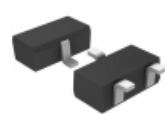
UNR921AJ0L
 TRANS PREBIAS NPN 125MW SSMINI3
[Panasonic Electronic Components](#)

RFQ

Panasonic
UNR921AG0L
[Panasonic](#)

RFQ

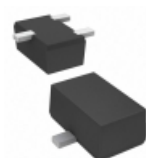
UNR921BG0L
 TRANS PREBIAS NPN 125MW SSMINI3
[Panasonic Electronic Components](#)

RFQ

Panasonic
UNR921AJ0L
[Panasonic](#)

RFQ

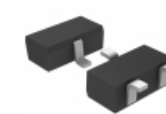
UNR921CJ0L
 TRANS PREBIAS NPN 125MW SSMINI3
[Panasonic Electronic Components](#)

RFQ

Panasonic
UNR921CJ0L
[Panasonic](#)

RFQ

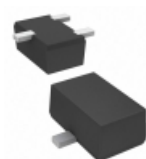
UNR921CG0L
 TRANS PREBIAS NPN 125MW SSMINI3
[Panasonic Electronic Components](#)

RFQ

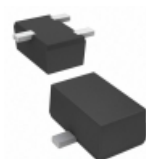
UNR921DG0L
 TRANS PREBIAS NPN 125MW SSMINI3
[Panasonic Electronic Components](#)

RFQ

UNR921DJ0L
 TRANS PREBIAS NPN 125MW SSMINI3
[Panasonic Electronic Components](#)

RFQ

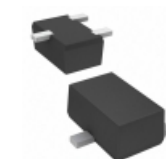
UNR921AG0L
 TRANS PREBIAS NPN 125MW SSMINI3
[Panasonic Electronic Components](#)

RFQ

Guess You May Looking For

BZT52B16-E3-18
 DIODE ZENER 500MW SOD-123
[Vishay Semiconductor Diodes Division](#)

RFQ

TZS4715-GS08
 DIODE ZENER 36V 500MW SOD80
[Vishay Semiconductor Diodes Division](#)

RFQ

MMSZ4713-G3-08
 DIODE ZENER 30V 500MW SOD123
[Vishay Semiconductor Diodes Division](#)

RFQ

1N5259BTA
 DIODE ZENER 39V 500MW DO35
[SMC Diode Solutions](#)

RFQ

CZRL5235B-G
 DIODE ZENER 6.8V 500MW SOD80
[Comchip Technology](#)

RFQ

SZMMSZ27T1G
 DIODE ZENER 27V 500MW SOD123
[ON Semiconductor](#)

RFQ

TFZGTR13B
 DIODE ZENER 13V 500MW TUMD2
[Rohm Semiconductor](#)

RFQ

3EZ13D5-TP
 DIODE ZENER 13V 3W DO15
[Micro Commercial Co](#)

RFQ

CZRA4742-HF
 DIODE ZENER 12V 1W DO214AC
[Comchip Technology](#)

RFQ

CZRER52C2V7
 DIODE ZENER 2.7V 150MW 0503
[Comchip Technology](#)

RFQ