

BD48K30G-TL

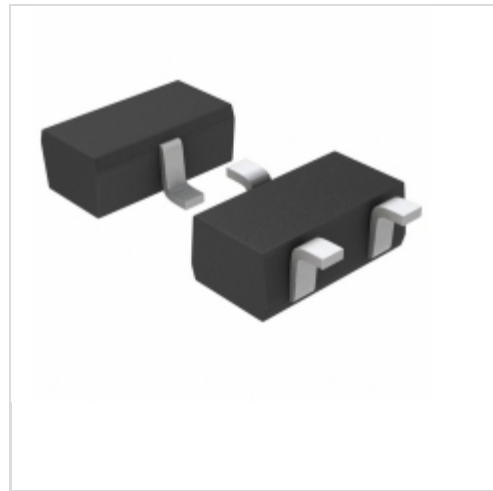

LAPIS Semiconductor

IC DETECTOR VOLT 3.0V OD SSOP3

Lead free / RoHS Compliant

Integrated Circuits (ICs)

[PDF](#) [BD48K30G-TL.pdf](#)

Buy Now

We can supply LAPIS Semiconductor BD48K30G-TL, use the request quote form to request BD48K30G-TL price, LAPIS Semiconductor Datasheet PDF and lead time. Zeanoit.com is a professional electronic components distributor. With 3+ Million line items of available electronic components can ship in short lead-time, over 250 thousand part numbers of electronic components in stock for immediately delivery, which may include part number BD48K30G-TL. The price and lead time for BD48K30G-TL depending on the quantity required, availability and warehouse location.

Out Stock

0 pcs

Minimum:1

Multiples:100

Manufacturer lead time 10 weeks

PRICE

3000 pcs	\$0.116
6000 pcs	\$0.109
15000 pcs	\$0.102
30000 pcs	\$0.093
65535 pcs	\$0.09

Shopping Process

1

Confirm the product

2

submit the order

3

payment

4

wait for delivery

5

receive the goods

Specifications

Voltage - Threshold:	3V
Type:	Simple Reset/Power-On Reset
Supplier Device Package:	3-SSOP
Series:	BD48xxx
Reset Timeout:	-
Reset:	Active Low
Packaging:	Tape & Reel (TR)
Package / Case:	TO-236-3, SC-59, SOT-23-3
Output:	Open Drain or Open Collector
Operating Temperature:	-40°C ~ 105°C (TA)
Number of Voltages Monitored:	1
Mounting Type:	Surface Mount

Related products

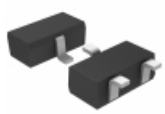

BD48K25G-TL
IC DETECTOR VOLT 2.5V OD SSOP3
[Rohm Semiconductor](#)

RFQ

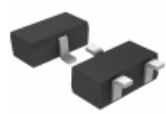

BD48K26G-TL
IC DETECTOR VOLT 2.6V OD SSOP3
[Rohm Semiconductor](#)

RFQ



BD48K28G-TL
IC DETECTOR VOLT 2.8V OD SSOP3
[Rohm Semiconductor](#)

RFQ



BD48K27G-TL
IC DETECTOR VOLT 2.7V OD SSOP3
[Rohm Semiconductor](#)

RFQ

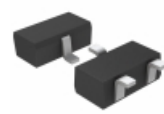

BD48K29G-TL
IC DETECTOR VOLT 2.9V OD SSOP3
[Rohm Semiconductor](#)

RFQ

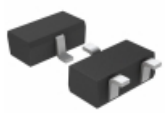

BD48K35G-TL
IC DETECTOR VOLT 3.5V OD SSOP3
[Rohm Semiconductor](#)

RFQ

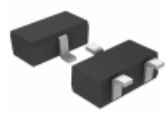

BD48K38G-TL
IC VOLTAGE SUPERVISOR 3SSOP
[Rohm Semiconductor](#)

RFQ

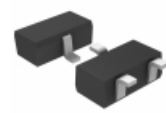

BD48K40G-TL
IC DETECTOR VOLT 4.0V OD SSOP3
[Rohm Semiconductor](#)

RFQ



BD48K33G-TL
IC DETECTOR VOLT 3.3V OD SSOP3
[Rohm Semiconductor](#)

RFQ

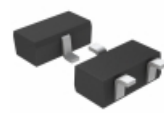

BD48K31G-TL
IC DETECTOR VOLT 3.1V OD SSOP3
[Rohm Semiconductor](#)

RFQ

Guess You May Looking For

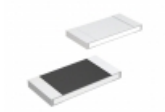

MCR10EZH11R5
RES SMD 11.5 OHM 1% 1/8W 0805
[Rohm Semiconductor](#)

RFQ

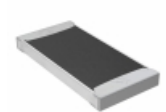

TNPW2512124RBEEG
RES SMD 124 OHM 0.1% 1/2W 2512
[Vishay Dale](#)

RFQ

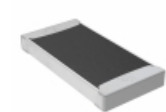

TNPW201011K3BETF
RES SMD 11.3K OHM 0.1% 0.4W 2010
[Vishay Dale](#)

RFQ

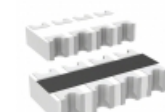

CAT16-820J4LF
RES ARRAY 4 RES 82 OHM 1206
[Bourns Inc.](#)

RFQ



4820P-T01-270
RES ARRAY 10 RES 27 OHM 20SOIC
[Bourns Inc.](#)

RFQ



4608X-102-470
RES ARRAY 4 RES 47 OHM 8SIP
[Bourns Inc.](#)

RFQ



PWR221T-30-10R0J
RES 10 OHM 30W 5% TO220
[Bourns Inc.](#)

RFQ

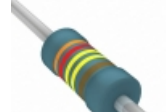

MBA02040C3244FRP00
RES 3.24M OHM 0.4W 1% AXIAL
[Vishay BC Components](#)

RFQ



CMF55300R00FLEB
RES 300 OHM 1/2W 1% AXIAL
[Vishay Dale](#)

RFQ



CMF55280R00FKEB70
RES 280 OHM 1/2W 1% AXIAL
[Vishay Dale](#)

RFQ