

**BD48K50G-TL**

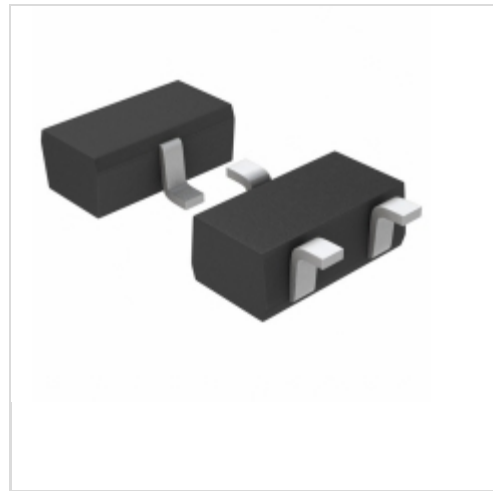

**LAPIS Semiconductor**  
IC DETECTOR VOLT 5.0V OD SSOP3  
Lead free / RoHS Compliant  
Integrated Circuits (ICs)

[BD48K50G-TL.pdf](#)

**Buy Now**

**Out Stock**  
**0 pcs**  
Minimum:1  
Multiples:100  
Manufacturer lead time 10 weeks

PRICE	
3000 pcs	\$0.116
6000 pcs	\$0.109
15000 pcs	\$0.102
30000 pcs	\$0.093
65535 pcs	\$0.09

We can supply LAPIS Semiconductor BD48K50G-TL, use the request quote form to request BD48K50G-TL price, LAPIS Semiconductor Datasheet PDF and lead time. Zeanoit.com is a professional electronic components distributor. With 3+ Million line items of available electronic components can ship in short lead-time, over 250 thousand part numbers of electronic components in stock for immediately delivery, which may include part number BD48K50G-TL. The price and lead time for BD48K50G-TL depending on the quantity required, availability and warehouse location.

Shopping Process

**1**

Confirm the product

**2**

submit the order

**3**

payment

**4**

wait for delivery

**5**

receive the goods

Specifications

<b>Voltage - Threshold:</b>	5V
<b>Type:</b>	Simple Reset/Power-On Reset
<b>Supplier Device Package:</b>	3-SSOP
<b>Series:</b>	BD48xxx
<b>Reset Timeout:</b>	-
<b>Reset:</b>	Active Low
<b>Packaging:</b>	Tape & Reel (TR)
<b>Package / Case:</b>	TO-236-3, SC-59, SOT-23-3
<b>Output:</b>	Open Drain or Open Collector
<b>Operating Temperature:</b>	-40°C ~ 105°C (TA)
<b>Number of Voltages Monitored:</b>	1
<b>Mounting Type:</b>	Surface Mount

Related products



**BD4901FM-E2**  
IC VOLT REGULATOR 28-HSOP  
Rohm Semiconductor

RFQ

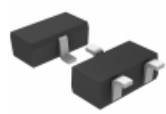

**BD48K60G-TL**  
IC DETECTOR VOLT 6.0V OD SSOP3  
Rohm Semiconductor

RFQ

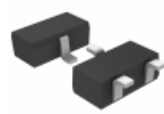

**BD48K42G-TL**  
IC DETECTOR VOLT 4.2V OD SSOP3  
Rohm Semiconductor

RFQ



**BD4900FM-E2**  
IC VOLT REGULATOR 28-HSOP  
Rohm Semiconductor

RFQ

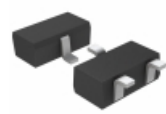

**BD48K43G-TL**  
IC DETECTOR VOLT 4.3V OD SSOP3  
Rohm Semiconductor

RFQ



**BD48L38G-TL**  
ROHM

RFQ

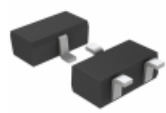

**BD48K44G-TL**  
IC DETECTOR VOLT 4.4V OD SSOP3  
Rohm Semiconductor

RFQ

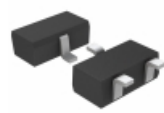

**BD48K46G-TL**  
IC DETECTOR VOLT 4.6V OD SSOP3  
Rohm Semiconductor

RFQ

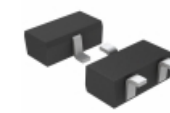

**BD48K45G-TL**  
IC DETECTOR VOLT 4.5V OD SSOP3  
Rohm Semiconductor

RFQ

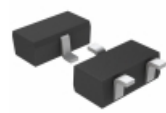

**BD48L44G-TL**  
IC VOLTAGE SUPERVISOR 3SSOP  
Rohm Semiconductor

RFQ

Guess You May Looking For



**9T06031A3303FBHFT**  
RES SMD 330K OHM 1% 1/10W 0603  
Yageo

RFQ



**MCR10EZHF1242**  
RES SMD 12.4K OHM 1% 1/8W 0805  
Rohm Semiconductor

RFQ



**MCR10EZPF1742**  
RES SMD 17.4K OHM 1% 1/8W 0805  
Rohm Semiconductor

RFQ

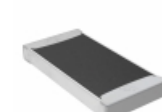

**TNPW20103K74BEEF**  
RES SMD 3.74K OHM 0.1% 0.4W 2010  
Vishay Dale

RFQ



**766163564GP**  
RES ARRAY 8 RES 560K OHM 16SOIC  
CTS Resistor Products

RFQ

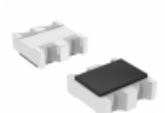

**CRB1A2E510JT**  
RES ARRAY 2 RES 51 OHM 0606  
AVX Corporation

RFQ

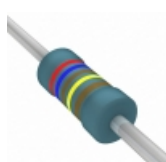

**HVR3700002614FR500**  
RES 2.61M OHM 1/2W 1% AXIAL  
Vishay BC Components

RFQ

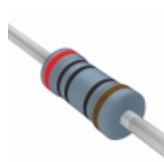

**MFR-25FRF52-200R**  
RES 200 OHM 1/4W 1% AXIAL  
Yageo

RFQ



**RNF14BAE187R**  
RES 187 OHM 1/4W .1% AXIAL  
Stackpole Electronics Inc.

RFQ



**RN55C2643BR36**  
RES 264K OHM 1/8W .1% AXIAL  
Vishay Dale

RFQ