

## S-1000N20-M5T1G

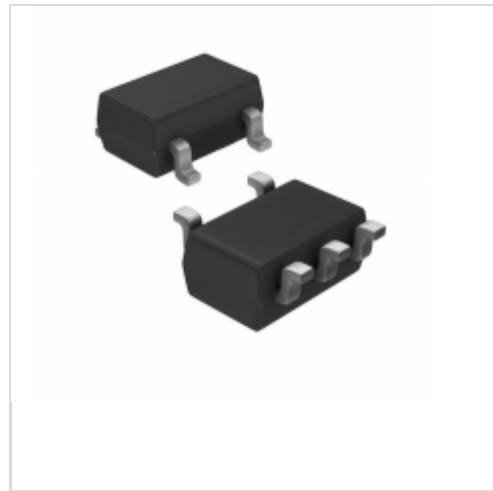

**SII Semiconductor Corporation**

IC VOLT DETECT N-CH 20V SOT23-5

Lead free / RoHS Compliant

Integrated Circuits (ICs)

[S-1000N20-M5T1G.pdf](#)

**Buy Now**

**Out Stock**

**0 pcs**

Minimum:1

Multiples:100

Manufacturer lead time 10 weeks

We can supply S-1000N20-M5T1G, use the request quote form to request S-1000N20-M5T1G price and lead time. Zeano is a professional electronic components distributor. With 3+ Million line items of available electronic components can ship in short lead-time, over 250 thousand part numbers of electronic components in stock for immediately delivery, which may include part number S-1000N20-M5T1G. The price and lead time for S-1000N20-M5T1G depending on the quantity required and warehouse location. Contact us and our sales representative will provide you price. We look forward to work with you.

### Shopping Process

**1**

**Confirm the product**

**2**

**submit the order**

**3**

**payment**

**4**

**wait for delivery**

**5**

**receive the goods**

### Specifications

<b>Voltage - Threshold:</b>	2V
<b>Type:</b>	Voltage Detector
<b>Supplier Device Package:</b>	SOT-23-5
<b>Series:</b>	S-1000
<b>Reset Timeout:</b>	-
<b>Reset:</b>	Active Low
<b>Packaging:</b>	Tape & Reel (TR)
<b>Package / Case:</b>	SC-74A, SOT-753
<b>Output:</b>	Open Drain or Open Collector
<b>Operating Temperature:</b>	-40°C ~ 85°C (TA)
<b>Number of Voltages Monitored:</b>	1
<b>Mounting Type:</b>	Surface Mount

### Related products



**S-1000N19-M5T1U**

IC VOLT DETECTOR

[SII Semiconductor Corporation](#)

**RFQ**



**S-1000N20-I4T1U**

IC VOLT DETECT N-CH 20V SNT-4A

[SII Semiconductor Corporation](#)

**RFQ**



**S-1000N19-N4T1U**

IC VOLT DETECTOR

[SII Semiconductor Corporation](#)

**RFQ**

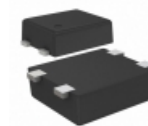

**S-1000N20-I4T1G**

IC VOLT DETECT N-CH 20V SNT-4A

[SII Semiconductor Corporation](#)

**RFQ**

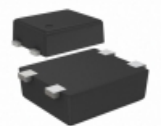

**S-1000N21-I4T1G**

IC VOLT DETECT N-CH 21V SNT-4A

[SII Semiconductor Corporation](#)

**RFQ**



**S-1000N20-N4T1G**

IC VOLT DETECT N-CH 20V SC-82AB

[SII Semiconductor Corporation](#)

**RFQ**



**S-1000N21-I4T1U**

IC VOLT DETECT N-CH 21V SNT-4A

[SII Semiconductor Corporation](#)

**RFQ**



**S-1000N20-M5T1U**

IC VOLT DETECTOR

[SII Semiconductor Corporation](#)

**RFQ**



**S-1000N20-N4T1U**

IC VOLT DETECTOR

[SII Semiconductor Corporation](#)

**RFQ**



**S-1000N19-N4T1G**

IC VOLT DETECT N-CH 19V SC-82AB

[SII Semiconductor Corporation](#)

**RFQ**

### Guess You May Looking For



**RG3216P-2430-C-T5**

RES SMD 243 OHM 0.25% 1/4W 1206

[Susumu](#)

**RFQ**



**768141390G**

RES ARRAY 13 RES 39 OHM 14SOIC

[CTS Resistor Products](#)

**RFQ**

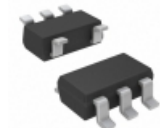

**MAX5492RA01100+T**

RES NETWORK 2 RES MULT OHM

SC74A

[Maxim Integrated](#)

**RFQ**



**RNC50H10R0FSRE6**

RES 10 OHM 1/10W 1% AXIAL

[Vishay Dale](#)

**RFQ**



**MK5622FE-R52**

RES 56.2K OHM 1/4W 1% AXIAL

[Ohmite](#)

**RFQ**

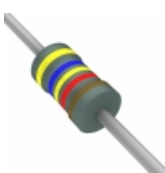

**RNF12FTD46K4**

RES 46.4K OHM 1/2W 1% AXIAL

[Stackpole Electronics Inc.](#)

**RFQ**



**CMF55619R00FKRE**

RES 619 OHM 1/2W 1% AXIAL

[Vishay Dale](#)

**RFQ**

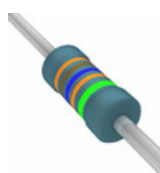

**MBB02070C3163DC100**

RES 316K OHM 0.6W 0.5% AXIAL

[Vishay BC Components](#)

**RFQ**

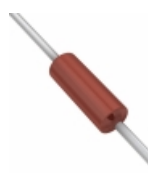

**CMF60221K00FKEA**

RES 221K OHM 1W 1% AXIAL

[Vishay Dale](#)

**RFQ**



**CMF5559K000DHEB**

RES 59K OHM 1/2W .5% AXIAL

[Vishay Dale](#)

**RFQ**